

1T8822DATR | CTEVO ARCHITECTURAL 78

Adjustable recessed LED projector in a trimless version

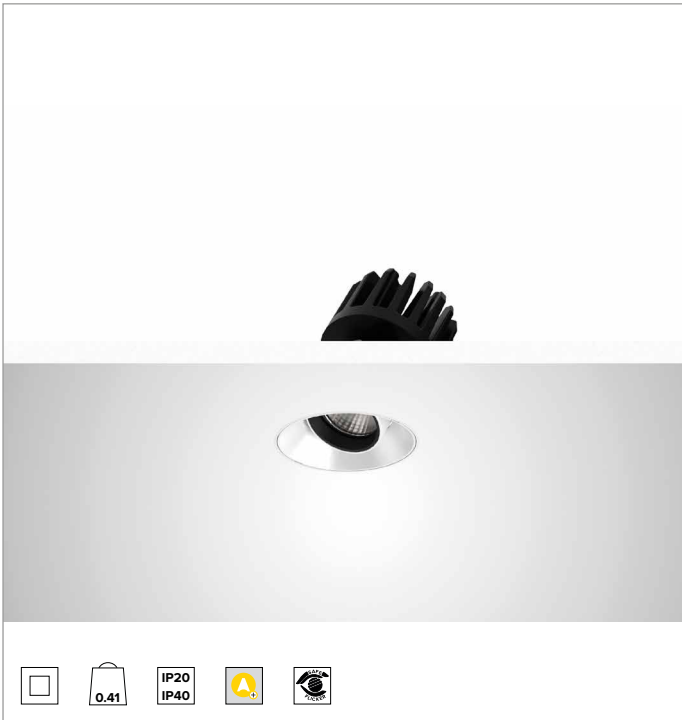

	2700K	H(m)	D(m)	Emax(lx)
	Ra90			42°
Fixture Power	13W	1	0.76	2443
Source Flux	1507lm	2	1.52	611
Fixture Flux	1114lm	3	2.28	271
Efficacy	85lm/W	4	3.04	153
TS1343	Imax=1621cd/klm	Imax	2443cd	5
			3.80	98

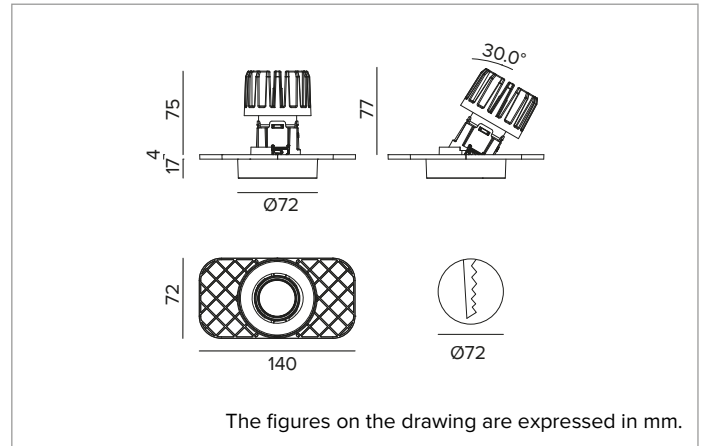

SOURCE

High efficiency Chip on Board LED Ra90. Ra80 on request.

Energy efficiency class: E

Nominal power: 12W

Nominal flux: 1507lm

Colour rendering index: 90

Rf: 92

Rg: 99

CCT nominal: 2700K

Lifetime (L80/B10): >50000h tq +25°C

ILLUMINOTECHNICAL CHARACTERISTICS

MWFL Version - a moulded white plastic optical holder with convex faceted highly reflective anodised aluminium precision optics, a holographic diffusion filter and a black silicone cut off ring. UGR<19 (EN 12464-1).

Optic: REFLECTOR

Beam angles: MWFL

Optical efficiency: 74%

Fixture flux: 1114lm

Luminous efficacy: 85lm/W

Photobiological safety: Compliant with RG1 low risk group

MECHANICAL CHARACTERISTICS

Moulded white plastic optic holder and die-cast aluminium heat sink in black color. White colour cover. The optical unit can be adjusted up to 30° on the vertical plane with a mechanical beam locking system (with access from the false ceiling), and 358° on the horizontal plane. Trimless version with a load-bearing element for installation and finishing in plasterboard.

Colour and finish: Plaster white

Weight: 0.41Kg

Version: TRIMLESS

Degree of protection: IP20 for recessed part

Degree of protection: IP40 for exposed part

ELECTRICAL CHARACTERISTICS

Integrated DALI driver. Luminaire compliant with EN 60598-2-22 for power supply from a centralised emergency system CPSS (Central Power Supply System), not incorporated in the luminaire - high risk areas excluded. The default power and flux are 100% in AC and 100% in DC.

Fixture Power: 13W

Power supply: 220-240Vac 50/60Hz

Insulation Class: CLASS 2

Type of driver / Control: DALI - PUSH

Driver included: YES

Class F: YES

SAFE FLICKER: PstLM<1 and SVM<0.4 (IEC TR 61547-1 and IEC TR 63158), to ensure a more comfortable and safe light

Ambient temperature: 0°C / +25°C

INSTALLATION

Quick tool-free mounting system for false ceiling installation from 0.5 to 30mm.

NOTES

Casambi control system available using a dedicated accessory. 110-277Vac version available on request. Commissioning of the control system via free APP; the intervention of a specialist technician can be quoted on request.

WARRANTY

5 years.

WARNING

Luminaire designed for disposal/recycling at end-of-life. Replaceable (LED only) light source by a professional. Replaceable control gear by a professional.

Due to the technological evolution of the electronic components, the data provided may be updated, and as such, confirmation must be requested during the order process.

Luminous flux and power supply have +/-10% tolerances with respect to the indicated value. tq +25°C (CIE 121).

We reserve the right to make technical changes.

Targetti Sankey S.r.l.
Via Pratese, 164
50145 Firenze - Italy
Tel: +39 055 37911
targetti.com
targetti@targetti.com

CCIAA Firenze
Share Capital:
€ 500.000,00
VAT N. (IT):
01537660480
R.E.A: FI-275656

TARGETTI

1T8822DATR | CCTEVO ARCHITECTURAL 78

Adjustable recessed LED projector in a trimless version

Accessories

Filter



Ø mm	Code
34	1T6931

PMMA holographic filter with blade effect to ovalize the light beam; more evident when combined with spot and flood optics.

Grid



Ø mm	Code
34	1T6930

Anti-glare louver.
Black painted metal honeycomb structure.
Complete with holographic diffusion filter.

Mounting System



L mm	Code
2500	1T9606

Anti-fall safety cable to secure the body of the appliance to the building structure.

Control systems



Code
1T5349

IP20 wireless control unit with DALI interface.
It generates a local DALI2 bus, enabling a direct connection to a DALI interface LED driver.
The module can only be used in a closed system and cannot be connected to an existing DALI network.
The module is wireless controlled using a Casambi app for smartphones and tablets using Bluetooth 5.0 technology.
The devices automatically create an adaptive, robust, and reliable wireless mesh network, allowing for the easy and efficient management of a high number of fixtures.
The control unit is preset to the DALI 1CH profile, meaning the device can control a single DALI driver with broadcast commands.
In addition to the DALI broadcast, other operating modes are available, such as:

- Button (normally open)
- Control unit 0/1-10V
- Control unit DALI Tunable White DT8
- Presence sensor



Code
2T0131

IP20 Extender for wireless control of LED driver with dimming DALI (or 1-10V) interface based on Casambi technology.
It has a DALI2 output with the capacity to control up to 40 lighting fixtures.
With the addition of a further external BUS DALI power supply it is possible to control up to 64 fixtures.
IP20 Extender is preset to the DALI broadcast profile, meaning all the luminaires connected to it are dimmable at the same level.
In addition to the DALI broadcast other operating modes are available, such as:

- EXTENDER DALI 8CH
- EXTENDER DALI Tunable White
- EXTENDER 0/1-10V
- EXTENDER DALI 4CH
- EXTENDER DALI DT8 Tunable White

Due to the technological evolution of the electronic components, the data provided may be updated, and as such, confirmation must be requested during the order process.
Luminous flux and power supply have +/-10% tolerances with respect to the indicated value. tq +25°C (CIE 121).

We reserve the right to make technical changes.

Targetti Sankey S.r.l.
Via Pratese, 164
50145 Firenze - Italy
Tel: +39 055 37911
targetti.com
targetti@targetti.com

CCIAA Firenze
Share Capital:
€ 500.000,00
VAT N. (IT):
01537660480
R.E.A: FI-275656

TARGETTI